

SECTION A-A

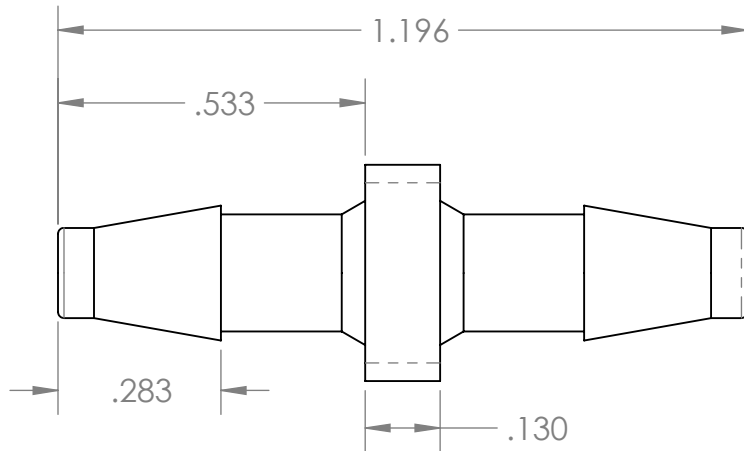
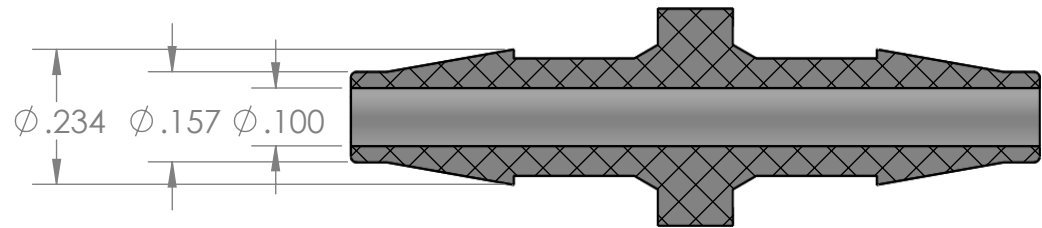

PROPRIETARY AND CONFIDENTIAL

Description

THE INFORMATION CONTAINED IN THIS DRAWING IS THE SOLE PROPERTY OF INDUSTRIAL SPECIALTIES MFG. AND IS MED SPECIALITES. ANY REPRODUCTION IN PART OR AS A WHOLE WITHOUT THE WRITTEN PERMISSION OF INDUSTRIAL SPECIALTIES MFG. AND IS MED SPECIALITES IS PROHIBITED.

5/32" Hose Barb Connector,
Natural Nylon

MFR# CAC42-NR0

NAME	DATE
M.E.	8/29/2016

PART#
VCA-532-N

REV
1

SHEET 1 OF 1

SCALE: 3:1

DO NOT SCALE DRAWING



Industrial Specialties Mfg.

IS Med Specialties

www.industrial-spec.com
800-781-8487