

SECTION A-A

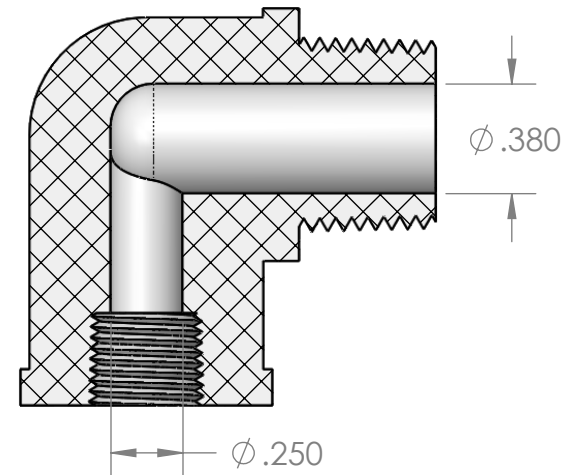

PROPRIETARY AND CONFIDENTIAL

Description

THE INFORMATION CONTAINED IN THIS DRAWING IS THE SOLE PROPERTY OF INDUSTRIAL SPECIALTIES MFG. AND IS MED SPECIALITES. ANY REPRODUCTION IN PART OR AS A WHOLE WITHOUT THE WRITTEN PERMISSION OF INDUSTRIAL SPECIALTIES MFG. AND IS MED SPECIALITES IS PROHIBITED.

3/8" Male NPT x 1/8" Female NPT Elbow,
Natural Nylon

MFR# GCX84-NR0

NAME	DATE
M.E.	10/3/2016

PART#
FM-6M2F-N

REV
1

SHEET 1 OF 1

SCALE: 3:2

DO NOT SCALE DRAWING



Industrial Specialties Mfg.

IS Med Specialties

www.industrialspec.com
800-781-8487