

SECTION A-A

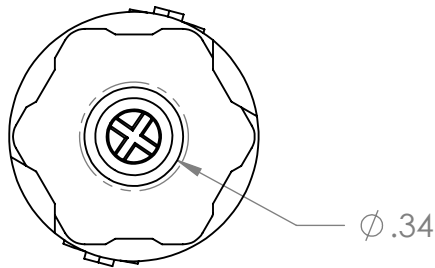
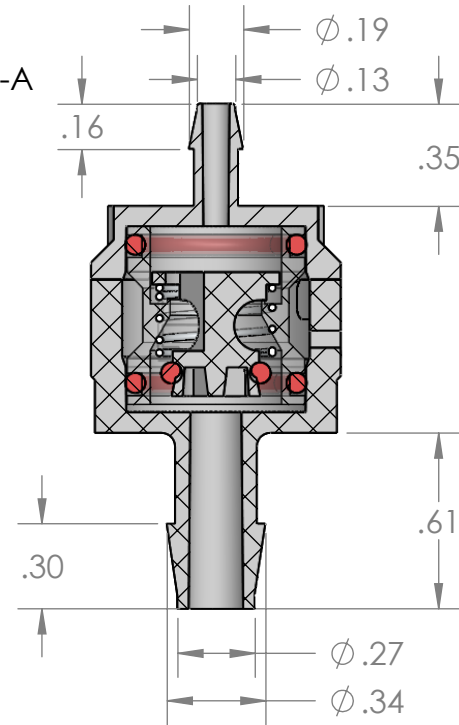

For Reference Only

PROPRIETARY AND CONFIDENTIAL

Description

THE INFORMATION CONTAINED IN THIS DRAWING IS THE SOLE PROPERTY OF INDUSTRIAL SPECIALTIES MFG. AND IS MED SPECIALITES. ANY REPRODUCTION IN PART OR AS A WHOLE WITHOUT THE WRITTEN PERMISSION OF INDUSTRIAL SPECIALTIES MFG. AND IS MED SPECIALITES IS PROHIBITED.

1/8" Hose Barb x 1/4" Hose Barb Modular Check Valve, Flow from 1/8" to 1/4", 30% Glass-Filled Polypropylene

NAME	DATE
M.E.	9/25/2018

PART#
CVIS-18-14

REV
1

SHEET 1 OF 1

SCALE: 1:1

DO NOT SCALE DRAWING

ISM Industrial Specialties Mfg. & IS MED Specialites (ISM)
industrialspec.com | 800-781-8486