

SECTION A-A
SCALE 1.5 : 1

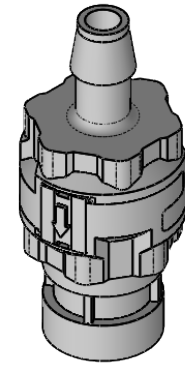
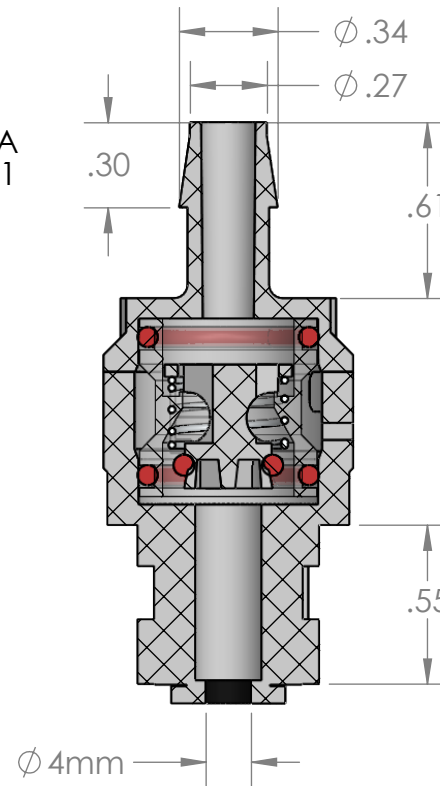

For Reference Only

PROPRIETARY AND CONFIDENTIAL

Description

THE INFORMATION CONTAINED IN THIS DRAWING IS THE SOLE PROPERTY OF INDUSTRIAL SPECIALTIES MFG. AND IS MED SPECIALITES. ANY REPRODUCTION IN PART OR AS A WHOLE WITHOUT THE WRITTEN PERMISSION OF INDUSTRIAL SPECIALTIES MFG. AND IS MED SPECIALITES IS PROHIBITED.

1/4" Hose Barb x 4mm Push-In Modular Check Valve, Flow from Barb to Push, 30% Glass-Filled Polypropylene

NAME	DATE
M.E.	10/4/2018

PART#
CVIS-14-4MM

REV
1

SHEET 1 OF 1

SCALE: 1:1

DO NOT SCALE DRAWING



industrialspec.com | 800-781-8486