

SECTION A-A

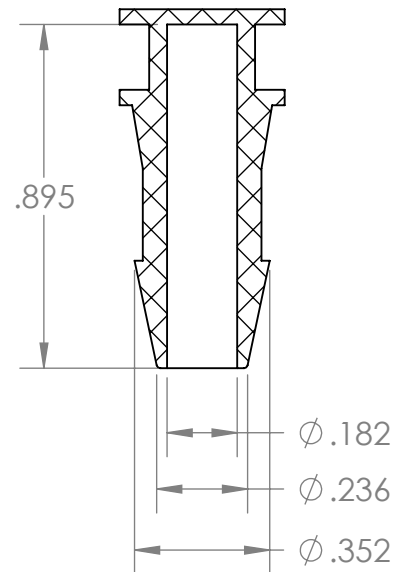
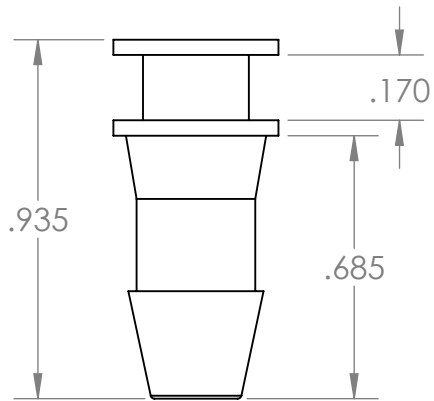

PROPRIETARY AND CONFIDENTIAL

**Description**

THE INFORMATION CONTAINED IN THIS DRAWING IS THE SOLE PROPERTY OF INDUSTRIAL SPECIALTIES MFG. AND IS MED SPECIALITES. ANY REPRODUCTION IN PART OR AS A WHOLE WITHOUT THE WRITTEN PERMISSION OF INDUSTRIAL SPECIALTIES MFG. AND IS MED SPECIALITES IS PROHIBITED.

1/4" Hose Barb Plug,  
Black Nylon

NAME	DATE
M.E.	3.22.2022

**PART#**

PJ-14-BN

REV  
1

SHEET 1 OF 1

SCALE: 2:1

DO NOT SCALE DRAWING



industrialspec.com | 800-781-8486