

NOTES:

1. ALL DIMENSIONS FOR REFERENCE ONLY
2. REFER TO AIR LOGIC'S POLYSULFONE APPLICATION GUIDE
3. TUBE RETENTION PRESSURE SUBJECT TO TUBING DIMENSION AND STIFFNESS
4. GASES MUST BE CLEAN AND DRY

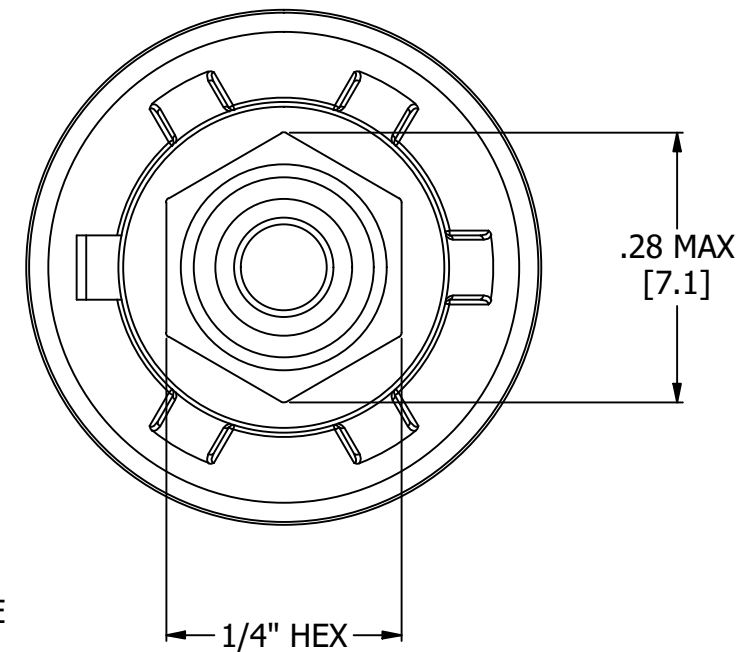
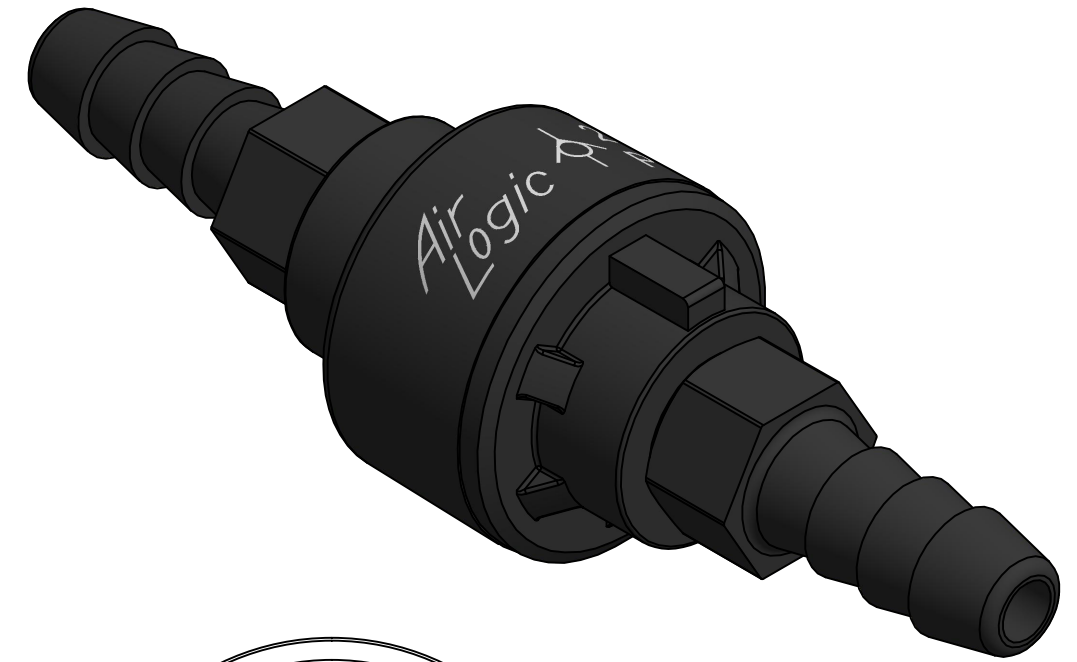
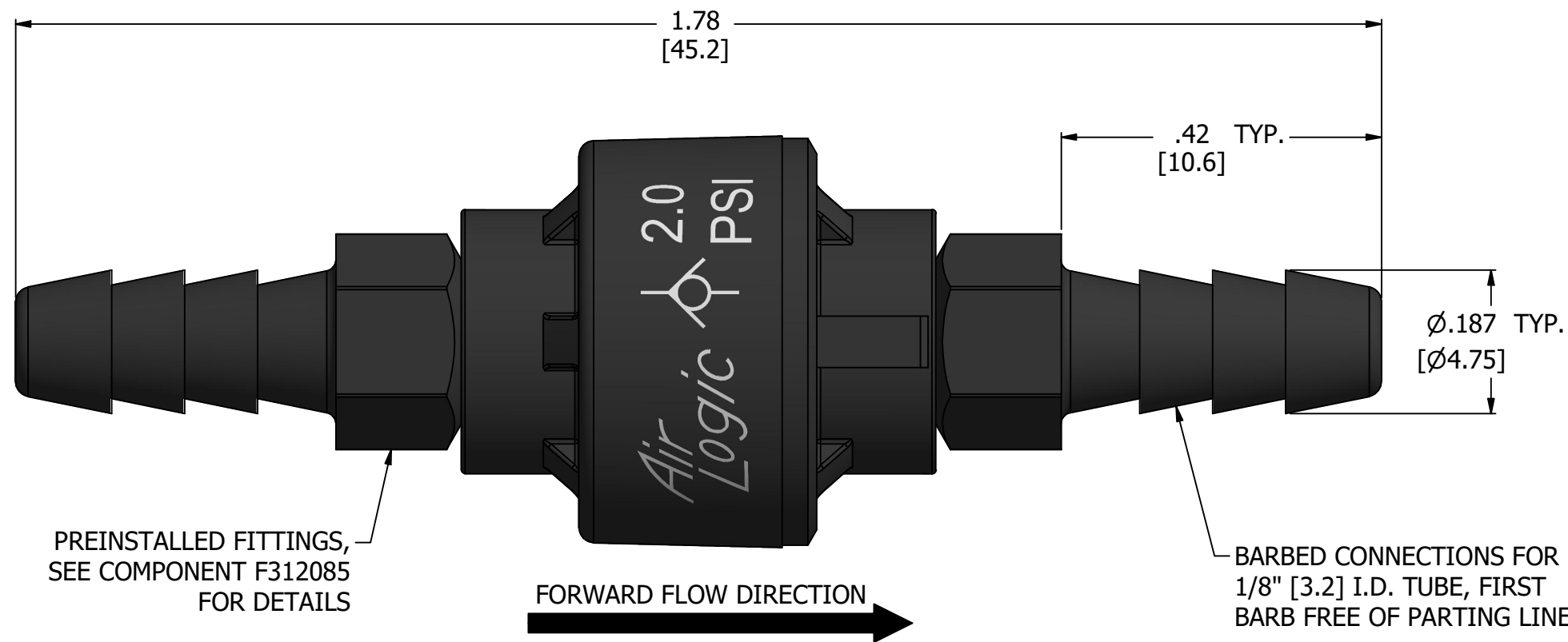

PRODUCT SPECIFICATIONS

COLOR(S)	BLACK HOUSING, WHITE PRINT
CHECK VALVE TYPE	SPRING LOADED, NORMALLY CLOSED
CRACKING PRESSURE	2 PSI, [134 MILLIBAR]
FORWARD FLOW AT 75 PSI SUPPLY PRESSURE	2.0 SCFM, [56.6 SLPM]
REVERSE FLOW AT 1 PSI DIFFERENTIAL	LESS THAN 0.06 SCIM, [.98 SCCM]
MEDIA	GASES, NOTE 2, NOTE 4
MAX INLET PRESSURE	75 PSI, [5.2 BAR]
TYPICAL TUBE RETENTION PRESSURE	125 PSI, [8.6 BAR], NOTE 3
WETTED MATERIALS	POLYSULFONE, SILICONE, NYLON, STAINLESS STEEL
RECOMMENDED SYSTEM FILTRATION	5 MICRON



**AIR-LOGIC** @ DIVISION OF KNAPP MFG, INC.  
 5102 DOUGLAS AVE RACINE, WI 53402  
 PHONE: (262) 639-9035 FAX: (262) 639-5996 WEB: AIR-LOGIC.COM

PART/DRAWING NO.:

**F28044042B85**

DESCRIPTION:  
 INLINE CHECK VALVE, 2 PSI, 1/8" BARBS

REVISION: B	DRAWN: 3/10/2021
SCALE: 5 : 1	SHEET SIZE: B

TERMS OF USE:  
 THIS DRAWING IS FOR INFORMATIONAL PURPOSES ONLY. AIR LOGIC MAKES NO REPRESENTATIONS OF WARRANTIES CONCERNING SUITABILITY FOR ANY PARTICULAR PURPOSE. ALL PRODUCTS SUPPLIED ARE SUBJECT TO TERMS AND CONDITIONS FOUND AT AIR-LOGIC.COM

DRAWING TAKES PRECEDENCE OVER 3D MODEL GEOMETRY

TOLERANCE: DECIMALS .00 ± .01, .000 ± .005, FRACTIONS ± 1/64  
 ANGLES 1/4° UNLESS OTHERWISE SPECIFIED  
 UNITS: INCHES [MILLIMETERS]