

 **Flow Direction**

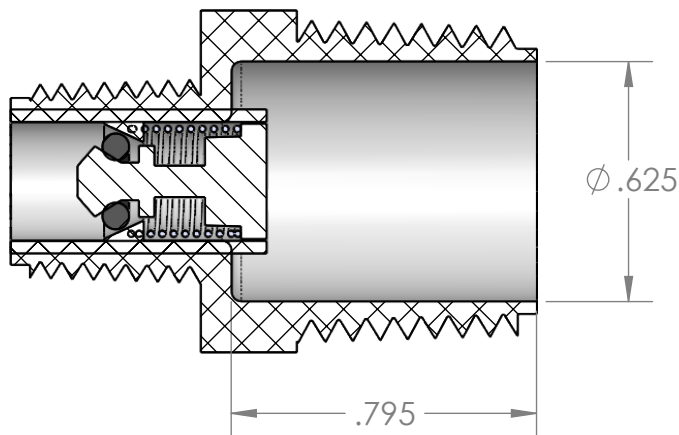

SECTION A-A

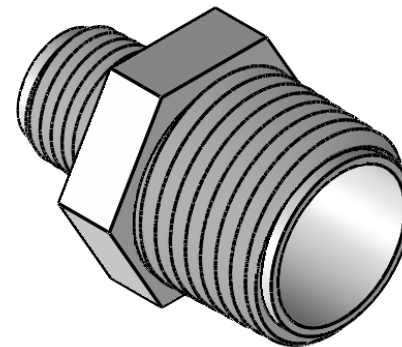
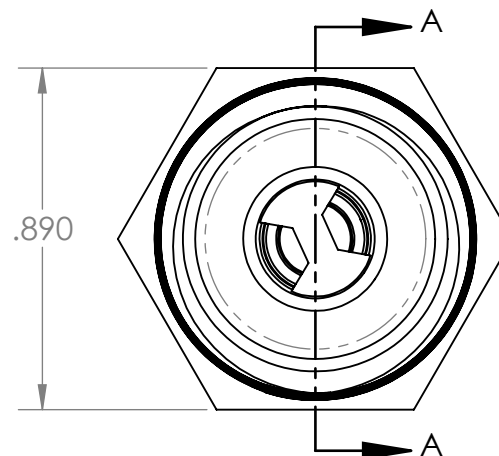
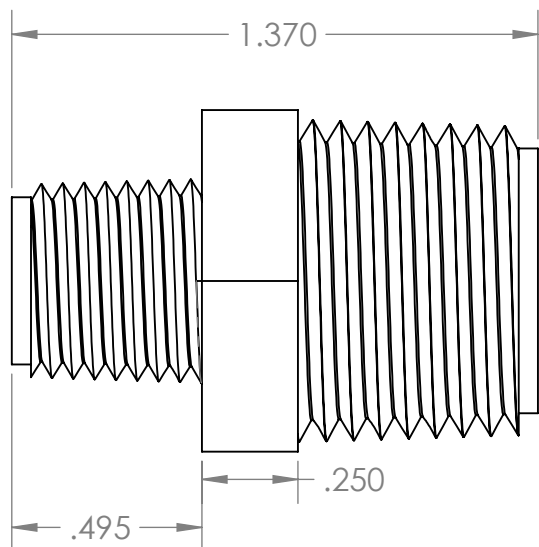

PROPRIETARY AND CONFIDENTIAL

**Description**

THE INFORMATION CONTAINED IN THIS DRAWING IS THE SOLE PROPERTY OF INDUSTRIAL SPECIALTIES MFG. AND IS MED SPECIALITES. ANY REPRODUCTION IN PART OR AS A WHOLE WITHOUT THE WRITTEN PERMISSION OF INDUSTRIAL SPECIALTIES MFG. AND IS MED SPECIALITES IS PROHIBITED.

1/2" Male NPT x 1/4" Male NPT Check Valve,  
1 psi Cracking Pressure, Flows from 1/2" to 1/4",  
Buna-N Seal, Nylon

NAME	DATE
M.E.	3.29.2021

**PART#**

CVNHPN-8M4M-BU-1 #

REV  
1

SHEET 1 OF 1

SCALE: 2:1

DO NOT SCALE DRAWING



industrialspec.com | 800-781-8486